



Model Number

NRN40-L3K-E2-C-V1

Features

- 40 mm non-flush
- Reduction factor = 1
- 40 mm non-flush
- Weld Immune
- Quick mounting bracket
- 4-way LED indicator

Connection

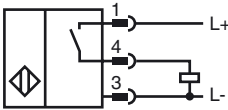

Pinout

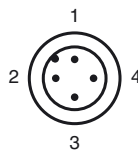

Wire colors in accordance with EN 60947-5-2

- | | | |
|---|----|---------|
| 1 | BN | (brown) |
| 2 | WH | (white) |
| 3 | BU | (blue) |
| 4 | BK | (black) |

Accessories

- V1-G**
4-pin, M12 female field-attachable connector
- V1-W**
4-pin, M12 female field-attachable connector
- V1-G-2M-PUR**
Cable socket, M12, 4-pin, PUR cable
- V1-W-2M-PUR**
Cable socket, M12, 4-pin, PUR cable
- MHW 01**

Dimensions

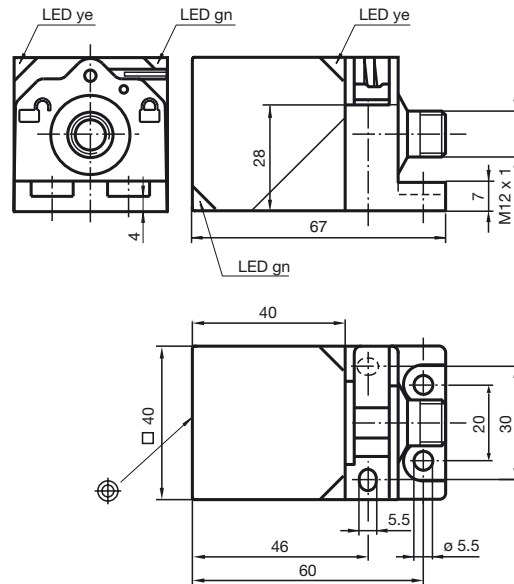

Technical Data

General specifications

Switching element function	PNP	NO
Rated operating distance	s_n	40 mm
Installation	non-flush	
Output polarity	switched high	
Assured operating distance	s_a	0 ... 32.4 mm
Reduction factor r_{Al}	1	
Reduction factor r_{Cu}	1	
Reduction factor r_{304}	1	
Reduction factor r_{317}	1	

Nominal ratings

Operating voltage	U_B	10 ... 30 V DC
Switching frequency	f	0 ... 100 Hz
Hysteresis	H	2 ... 15 %
Reverse polarity protected	reverse polarity protected	
Short-circuit protection	pulsing	
Voltage drop	U_d	≤ 2.5 V
Operating current	I_L	0 ... 200 mA
Off-state current	I_r	0 ... 0.5 mA typ. 0.01 mA
No-load supply current	I_0	≤ 25 mA
Constant magnetic field	B	200 mT
Alternating magnetic field	B	200 mT
Operating voltage display	LED, green	
Indication of the switching state	LED, yellow	

Functional safety related parameters

MTTF _d	1002 a
Mission Time (T_M)	20 a
Diagnostic Coverage (DC)	0 %

Ambient conditions

Ambient temperature	-25 ... 70 °C (-13 ... 158 °F)
Storage temperature	-40 ... 85 °C (-40 ... 185 °F)

Mechanical specifications

Connection type	Device connector M12 x 1, 4-pin
Housing material	GD-ZnAl4Cu1, coated mounting flange PA6-GF35
Sensing face	PA 6 Grivity GVN-35H
Protection degree	IP67
Mass	180 g

Compliance with standards and directives

Standard conformity	
Standards	EN 60947-5-2:2007 IEC 60947-5-2:2007

Approvals and certificates

Protection class	II
Rated insulation voltage	U_i 60 V
Design-impulse-voltage withstand	U_{imp} 800 V
UL approval	cULus Listed, General Purpose
CSA approval	cCSAus Listed, General Purpose
CCC approval	Products with a maximum operating voltage of ≤ 36 V do not bear a CCC marking because they do not require approval.

Release date: 2012-06-22 16:28 Date of issue: 2012-06-22 220063_eng.xml